

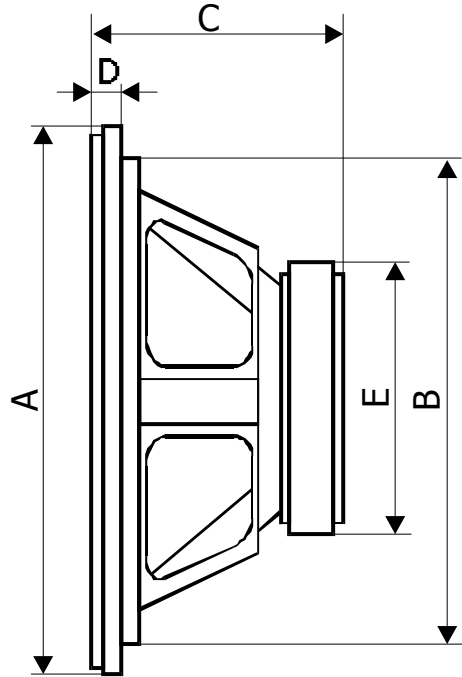

SBX 2030



A	Külső átmérő Diameter Durchmesser	204 mm
B	Beépítési átmérő Mounting cutout Einbauöffnung	183 mm
C	Beépítési mélység Mounting depth Einbautiefe	102 mm
D	Perem vastagság Edge width Randstreifen	9 mm
E	Mágnes átmérő Magnet diameter Magnetdurchmesser	120 mm