

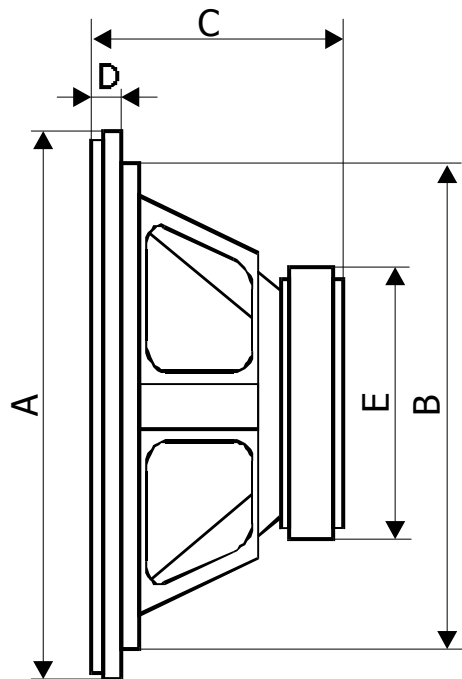

SBX 1010



A	Külső átmérő Diameter Durchmesser	105 mm
B	Beépítési átmérő Mounting cutout Einbauöffnung	93 mm
C	Beépítési mélység Mounting depth Einbautiefe	65 mm
D	Perem vastagság Edge width Randstreifen	7 mm
E	Mágnes átmérő Magnet diameter Magnetdurchmesser	80 mm